

UNOLASTIC

ONE-COMPONENT WATER-BASED ELASTOMERIC BITUMEN
WATERPROOFING PRODUCT,
THAT CAN BE COATED WITH CEMENT MORTAR AND PAINT

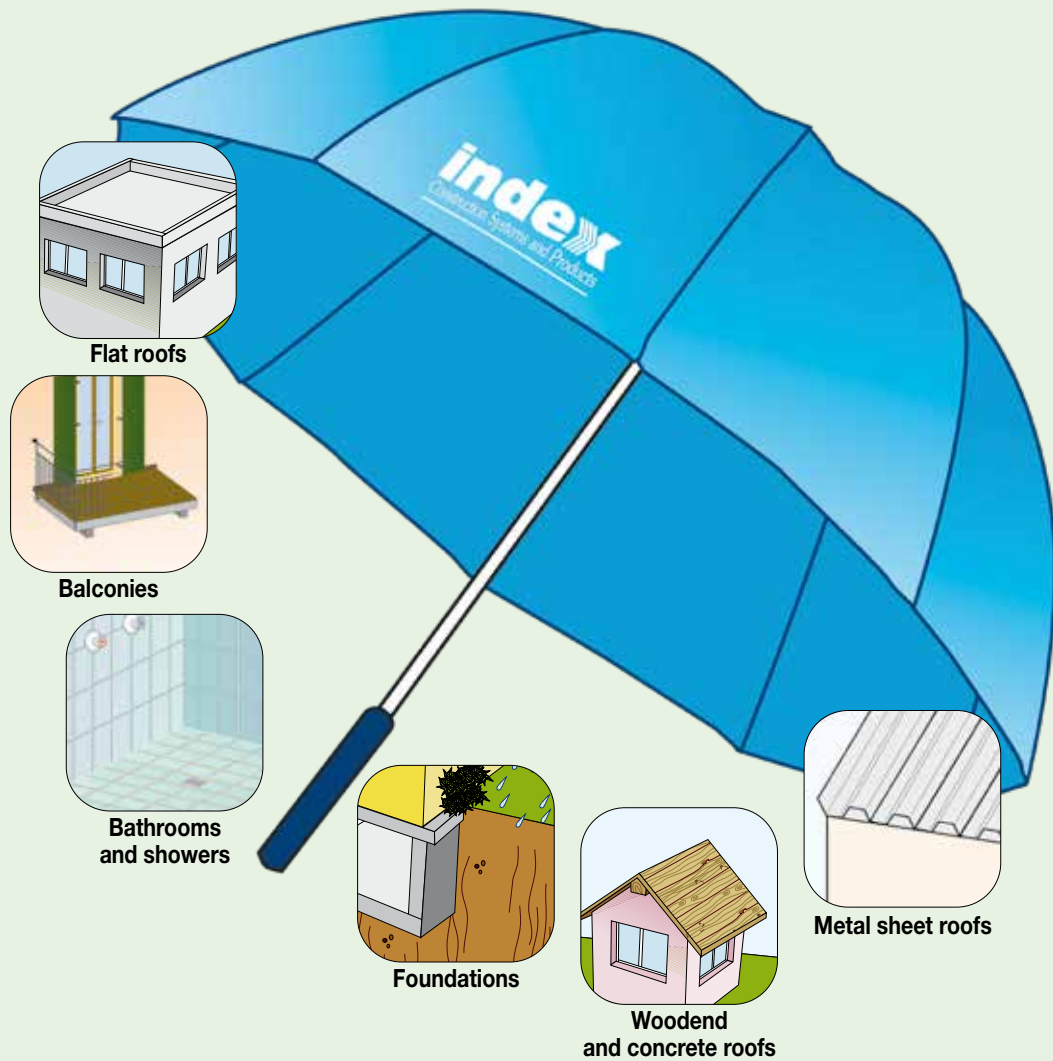

BROWN

GRAY

BLACK





20 kg

10 kg

5 kg

BROWN

GRAY

BLACK

UNOLASTIC

ONE-COMPONENT WATER-BASED ELASTOMERIC BITUMEN WATERPROOFING PRODUCT, THAT CAN BE COATED WITH CEMENT MORTAR AND PAINT.

IT CAN BE LEFT EXPOSED AND OCCASIONALLY BE SUBJECT TO FOOT TRAFFIC. IT IS RESISTANT AGAINST WATER STAGNATION.

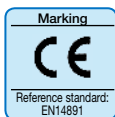
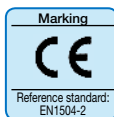

GRANTS *LEED* CREDITS

INDEX, a world leader in waterproofing systems for any external and internal surface, has developed a modern one-component high performance system that is easy to apply, flexible and can be coated

UNOLASTIC one-component water-based waterproofing product, it's ready to use and guarantees waterproofing of small surfaces even without the use of reinforcement. If the reinforcement fabric RINFOTEX PLUS or RINFOTEX EXTRA is used, the system reaches the very high performance levels required to guarantee waterproofing of large surfaces. It is an advanced and long-lasting waterproofing solution and it is easy to lay, hence increasing the safety of the whole system. The simplest and quickest waterproofing system to apply. It's a specific product for waterproofing foundations before laying ceramics, natural stones and glass mosaic.

CHARACTERISTICS			ENVIRONMENTAL	METHOD OF USE				PRECAUTIONS
ONE-COMPONENT	WATER BASED	WATERPROOFING	ECO GREEN	APPLY BY BRUSH	APPLY BY ROLLER	APPLY BY INOX SPATULA	APPLY MECHANICALLY USING A SPRAY PUMP	STORAGE: KEEP AWAY FROM FROST

PI-MC-IR
SUPERFICIAL PROTECTIVE COATING

DM
OP
WATER-BASED WATERPROOFING

UNOLASTIC is a one-component creamy, ready-to-use paste in water solution, available in grey, black and brown colour, obtained by mixing special elastic synthetic resins, bitumen and quartz filler, with high water resistance. It's ready to use, it does not require water or electricity current, hence making it faster and easier to lay. When laying, no electric mixers are needed and if the application is interrupted, the bucket can simply be closed, leaving the product perfectly ready to use next time. The paste thus obtained, once dried, is highly elastic, adheres to the surface excellently and is outstandingly waterproofing.

READY TO USE

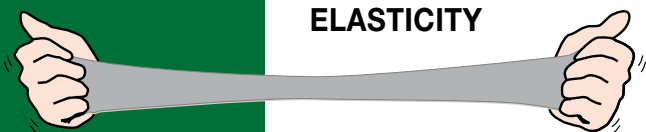

HIGH ELASTICITY

EXCELLENT ADHESION TO SURFACE



EXCELLENT WATERPROOFING



IT ADHERES TO THE MOST COMMON SUPPORTS:

- concrete
- screeds
- floors
- metal
- plaster
- plasterboard
- wooden surfaces
- polystyrene

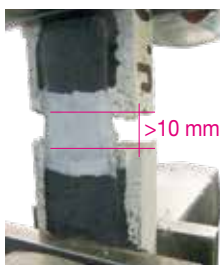

Crack-Bridgin Ability: designed and calibrated to overcome characteristic dimensional movements of foundations and coatings and to guarantee maximum adhesion of the bonded system.

UNOLASTIC with RINFOTEX PLUS reinforcement

Greater yield and laying time: thanks to the innovative very workable formulation, it waterproofs 30% of surfaces more than a two-component product. This is a great advantage for the applicator and for the site, which turns out to be higher.



UNOLASTIC is a product with a low environmental impact. For each can we avoid product put on the market to replace two-component waterproofing systems in plastic tanks, the emission into the atmosphere of about 1.5 kg of CO₂. The technology also eliminates the quantity of concrete needed for reaching optimal performance, hence saving about another 4.5 kg of CO₂. UNOLASTIC is a waterproofing product with low volatile organic substances emissions. This is a great step forward for the health of the people applying it and the protection of the atmosphere.

UNOLASTIC ANTI-ROOT is the version with root inhibitor added, making it resistant to plant roots.

UNOLASTIC is used to waterproof - both vertical and horizontal - concrete and metal surfaces, plasters, plasterboard, wood, cement based surfaces or plastered surfaces in general, or ceramic tiled floors and walls. It is used to waterproof wood, concrete and metal sheet roofs, balconies, terraces/flat roofs, foundations, bathrooms, saunas, showers, swimming pools and difficult places (vases, flower pots). **UNOLASTIC** can be used as an elastic lining to waterproof concrete and protect it from aggressive atmospheric gases such as CO_2 - SO_2 .



WOODEND AND CONCRETE ROOFS

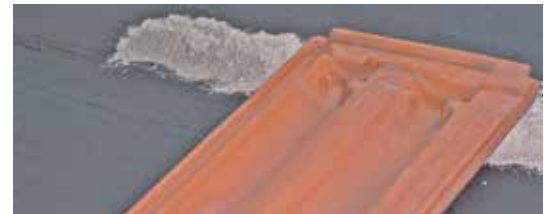
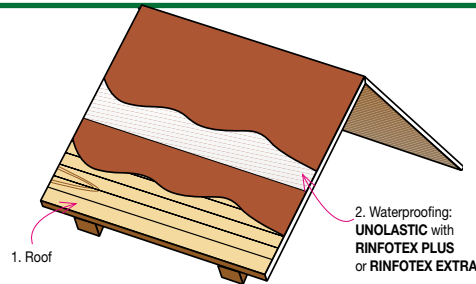

Curved tiles or shingles can be laid on UNOLASTIC fixing them straight onto mortar strips



FLAT ROOFS

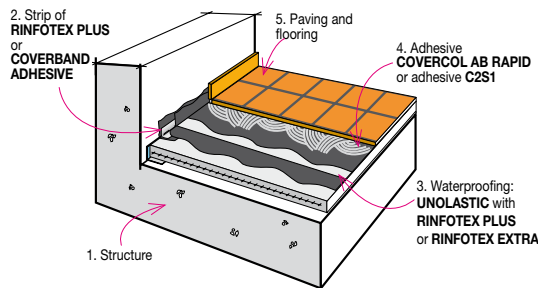

Tiles can be laid onto UNOLASTIC using adhesives C2S1



BALCONIES

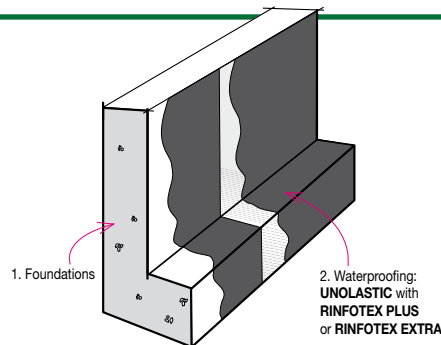

Protect the waterproofing with PROTEFON TEX or EPS panels

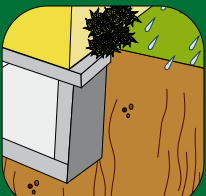

FOUNDATIONS

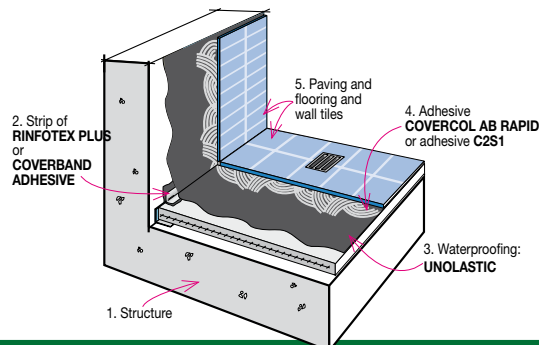

UNOLASTIC can be used to waterproof bathrooms and shower without using reinforcement

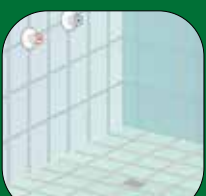

BATHROOMS AND SHOWERS



METAL DECKS ROOFS

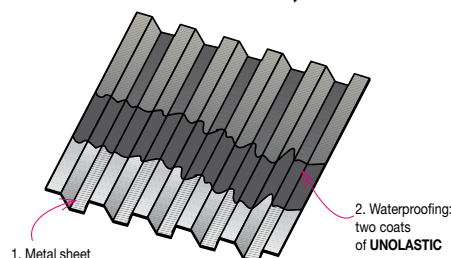

UNOLASTIC can be painted over with WHITE REFLEX reflecting paint or ELASTOLIQUID S paint

APPLICATION WARNINGS AND CONDITIONS TO BE AVOIDED

Storage: UNOLASTIC must be stored in a cool place at temperatures above +5°C and protected from direct sunlight. It cannot be used once frozen.



Weather conditions: Do not apply in bad weather conditions because the damp layer could be washed away with rainwater or ruined by dew or frost.



Do not apply in extremely hot or cold conditions. The correct application temperature is +5°C÷+35°C. With temperatures less than +10°C, add the additive ACCELERATOR to reduce the product drying time.

ACCELERATOR



ACCELERATOR is a pre-batched additive to accelerate setting in winter.

It can be observed how in the rain simulation test carried out within 24 hours of application, UNOLASTIC with ACCELERATOR added, manages to guarantee better resistance against being washed away.

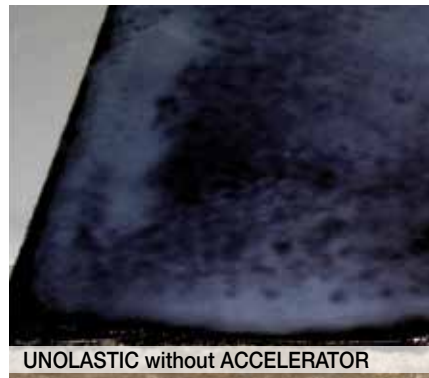

UNOLASTIC without ACCELERATOR



UNOLASTIC with ACCELERATOR

Damp surfaces: It can also be applied on slightly damp surfaces (humidity <3%). Laying on damp supports causes:

- Consistent delays in drying times;
- The formation of bubbles and detachment of the product due to evaporation.



Bubbles caused by a damp support

Big surfaces: For surfaces of more than 25 m² or for surfaces subject to strain, it is recommended to reinforce the product with RINFOTEX EXTRA or RINFOTEX PLUS buried in the first coat while it is still wet. The reinforcement overlaps must be 10 cm.

RINFOTEX PLUS

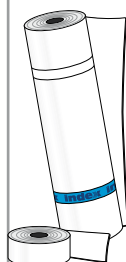

This is a reinforcement in non-woven polypropylene fabric, 100% stabilised. It is laid and incorporated into the waterproofing with UNOLASTIC to obtain better resistance characteristics.

RINFOTEX EXTRA

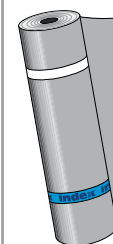

Non-woven lined polyester fabric reinforcement. It is laid and incorporated in the UNOLASTIC product to improve its waterproofing strength even further.

Drinking water storage tanks: It is not suitable for painting concrete drinking water storage tanks.

APPLICATION WARNINGS AND CONDITIONS TO BE AVOIDED

Compatibility with polymer-bitumen membranes:

UNOLASTIC can be used for localised repairs or to fulfil details exclusively on slate-treated membranes, after cleaning the surface. Do not use on talc or sand-treated surfaces or on Texflamina or gloss films etc.



Waterproofing details with polymer-bitumen membranes:

the details are fulfilled with UNOLASTIC before laying the polymer-bitumen membrane. After fulfilling the details with UNOLASTIC, it is very important to leave them set before laying the membrane.

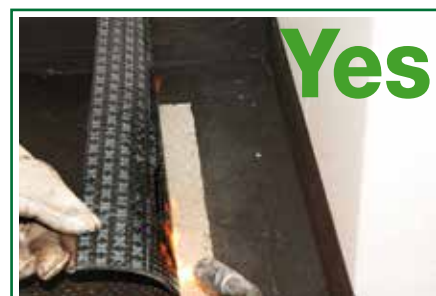

WARNING: strictly avoid inverting the laying phases; in other words, do not lay the membrane first and then fulfil the details with UNOLASTIC. The film of UNOLASTIC would detach, should it be applied on membranes without slate-treated surfaces.



Detachment of UNOLASTIC from talced surface of the membrane



INDEX METHOD OF USE

SURFACE PREPARATION	page 7
WATERPROOFING FRACTIONING AND PERIMETER JOINTS (with Coverband Adhesive)	page 8
WATERPROOFING STRUCTURAL JOINTS IN RELIEF	page 10
WATERPROOFING FLUSH STRUCTURAL JOINTS	page 11
WATERPROOFING THE CORNERS	page 12
WATERPROOFING THE PERIMETER JOINT (WALL-FLOOR) (with Rinfotex Plus)	page 13
WATERPROOFING (General rules)	page 14
APPLICATION OF VENT	page 15
APPLICATION OF DRAIN	page 16
WATERPROOFING A ROOF - GUTTER DETAIL	page 17
PATCHING UP SLATED COVERINGS	page 18

STRATIFIED ELEMENTS OF THE WATERPROOFING SYSTEM

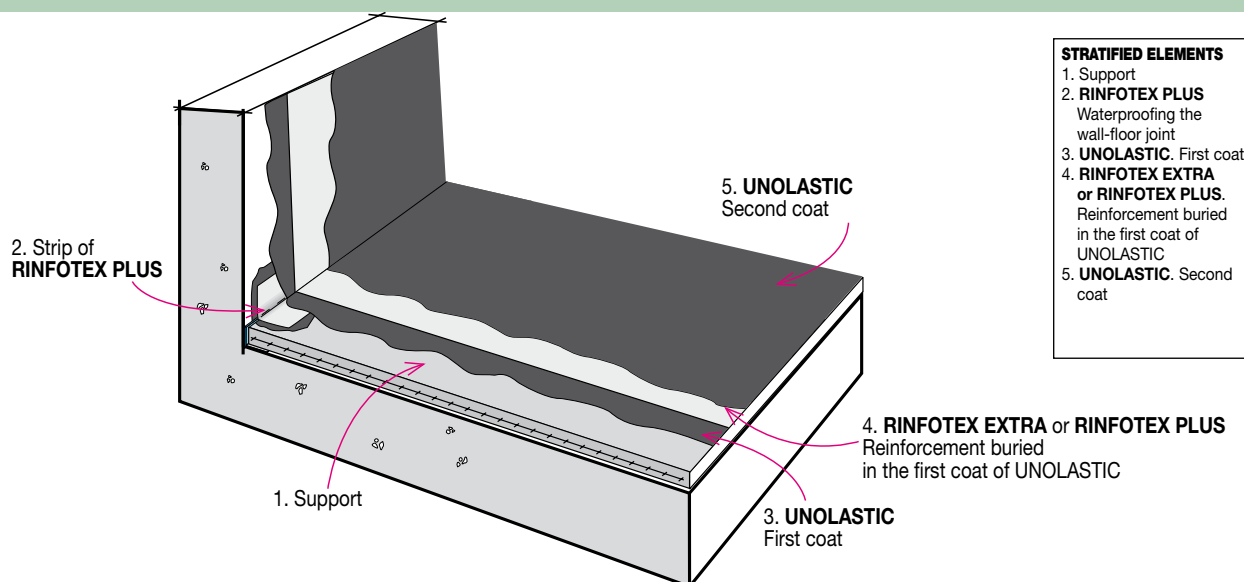

• Preparing the surface

The concrete surfaces must be dry, perfectly clean and free from dust, oil, grease, non-uniform and crumbling or weakly anchored parts, remains of concrete, lime, plaster or paint. Check smoothers of the foundation, the mechanical features, the surface consistency, the presence of suitable inclinations and the residual humidity. Damp supports (humidity >3%) must be treated with PRIMERBLOCK AB which is the suitable primer to stop vapour in order to avoid detachments and bubbles, with a consumption of 1.5 kg/m², or, alternatively, use epoxy cement primer EPOSTOP ABC, for a consumption of 700 g/m². Deteriorated parts must be reinstated with special mortars RESISTO range to obtain an even and compact surface. In case overlapping on old floors, the anchoring must be checked; tiles that could possibly detach must be removed and their cavity grouted with quick-setting cement mortar. For crumbling surfaces, apply the water-based primer PRIMER FIX using about 300 g/m².

• Waterproofing the wall-floor joints

Structural expansion joints must be designed based on the dimensions and on strain.

Expansion and perimeter joints must be sealed using the sealing tape COVERBAND ADHESIVE.

• Waterproofing with UNOLASTIC

24 hours after using any primer, apply the one-component elastomeric bitumen waterproofing **UNOLASTIC**.

Mix the product if necessary and apply with a smooth trowel, brush or roller with a thickness of about 1 mm pressing to obtain maximum adhesion to the surface. When the product has set, after removing any surface condensation, apply the second coat of UNOLASTIC to create a total, continuous and uniform thickness of about 1,5-3 mm.

Anyway perimeter joints laid between floor and wall must be reinforced with RINFOTEX PLUS. For surfaces of more than 25 m² or for supports subject to strain, it is recommended to reinforce the product with RINFOTEX PLUS or RINFOTEX EXTRA buried in the first coat while it is still wet. The reinforcement overlaps must be 10 cm. The parts turned over on the wall must not exceed the height of the skirting board or go beyond the maximum contact level with water. Internal and external corners will be prepared by cutting shaped reinforcement pieces. The reinforcement must always be turned up the vertical lines making sure the fabric adheres perfectly in the corners and edges with special attention to impregnation. The second coat can be applied "fresh on fresh" if the first coat has been reinforced, otherwise the following day if it has not.

UNOLASTIC is applied with a paintbrush, large brush, roller, trowel or spray gun with dedicated equipment, both on walls and floors.

To obtain an even layer when applying by trowel, it is recommended to use a toothed trowel with teeth of 4-6 mm and then go over the surface again with the smooth part to obtain an even layer of approximately 2 mm. After 4 days at 20°C the material is dry (in cold winter temperatures use the setting accelerator additive called **ACCELERATOR**) and ready for seal tests, if necessary, or it can be coated with cement-based material such as adhesives for tiles in the case of bathrooms, terraces/flat roofs etc. or with cement-based protection plaster in the case of foundations or with cement-based bedding mortar for roof tiles or shingles in the case of pitched roofs, or painted with **ELASTOLIQUID S** for covering cracks in external walls.

UNOLASTIC can be occasionally subject to foot traffic.

COVERAGE: 1,5 Kg/m² × mm thickness.

Average consumption for two layers of product without reinforcement: approx. 2-2,5 kg/m²

Product's average consumption using reinforcement: approx. 3 - 3,5 kg/m²

SURFACE PREPARATION

- 1** Clean off any dust, oils, grease, crumbling or weakly anchored parts, remains of concrete, lime, plaster or paint



- 2** Check the screed is level and that the surface has a sufficient slope to ensure outflow of stormwater



- 3** Check the consistency of the surface of the screed to guarantee maximum adhesion of the waterproofing membrane



- 4** Check the final mechanical features of the screed, which must be suitable for the intended use.
Check the anchoring and the cleaning of old floors in the event of overlapping



- 5** Check that the residual humidity has reached $\leq 3\%$. Screeds carried out with DRYCEM PRONTO are suitable for waterproofing after 24 hours in standard conditions

Humidity
 $\leq 3\%$

- 6** Laying any primer:
- PRIMERBLOCK AB or EPOSTOP ABC on damp substrates;
 - PRIMER FIX on crumbling substrates;
 - PRIMER T to protect screeds before laying



WATERPROOFING FRACTIONING AND PERIMETER JOINTS (with Coverband Adhesive)

- 1** Clean the joint, removing dust and various other leftovers using a vacuum cleaner.



- 2** Remove the silicone-coated film and apply the COVERBAND ADHESIVE over the joint.



- 3** Using a roller, apply enough pressure on the COVERBAND ADHESIVE strip so that it bonds perfectly to the surface.



- 4** Apply the COVERBAND ADHESIVE over the perimeter joint.
(Alternatively to COVERBAND, the perimeter joint can be waterproofed with strips of RINFOTEX PLUS - see page 13)



WATERPROOFING FRACTIONING AND PERIMETER JOINTS (with Coverband Adhesive)

- 5** Before you apply UNOLASTIC, position a strip of adhesive tape to identify the position of the joint after waterproofing with UNOLASTIC.



- 6** Spread UNOLASTIC evenly and abundantly over the horizontal surface to obtain a minimum thickness of 1.0 mm.



- 7** Lay RINFOTEX EXTRA or RINFOTEX PLUS over UNOLASTIC whilst still wet and press so that it bonds uniformly.



- 8** Cover RINFOTEX EXTRA or RINFOTEX PLUS thoroughly with UNOLASTIC with a total coverage approx 3-3.5 kg/m².



- 9** Apply an abundant coat (approximately 1.0 mm) of UNOLASTIC over the perimeter joint between the floor and wall up to the required height.



- 10** Finish the laying application of UNOLASTIC by removing the adhesive protection and identification tapes.



WATERPROOFING STRUCTURAL JOINTS IN RELIEF

- 1** Clean the joint, removing dust and various other leftovers using a vacuum cleaner.



- 2** Torch-bond a strip of polymer-bitumen membrane with mineral finish (MINERAL HELASTA - Index), positioning it in an Omega shape.



- 3** Spread UNOLASTIC evenly and abundantly over the horizontal surface to obtain a minimum thickness of 1.0 mm.



- 4** Lay RINFOTEX EXTRA or RINFOTEX PLUS over UNOLASTIC whilst still wet and press so that it bonds uniformly by totally wetting the reinforcement.



- 5** Cover RINFOTEX EXTRA or RINFOTEX PLUS thoroughly with UNOLASTIC with a total coverage approx 3-3.5 kg/m².



- 6** The waterproofing application of the protruding structural joint with UNOLASTIC is thus complete.



WATERPROOFING FLUSH STRUCTURAL JOINTS

- 1** Clean the joint, removing dust and various other leftovers using a vacuum cleaner.



- 2** Mill the concrete to create a seat for the membrane. Torch-bond a strip of polymer-bitumen membrane with mineral finish (MINERAL HELASTA - Index), positioning it in an Omega shape.



- 3** Spread UNOLASTIC evenly and abundantly over the horizontal surface to obtain a minimum thickness of 1.0 mm.



- 4** Lay RINFOTEX EXTRA or RINFOTEX PLUS over UNOLASTIC whilst still wet and press so that it bonds uniformly by totally wetting the reinforcement.



- 5** Cover RINFOTEX EXTRA or RINFOTEX PLUS thoroughly with UNOLASTIC with a total coverage approx 3-3.5 kg/m².



- 6** The waterproofing application of the flush structural joint with UNOLASTIC is thus complete.





QR code



TAG

METHOD OF USE

WATERPROOFING THE CORNERS

- 1** For every corner to be waterproofed prepare a piece of RINFOTEX PLUS measuring about 15×15 cm following the indicated diagram.

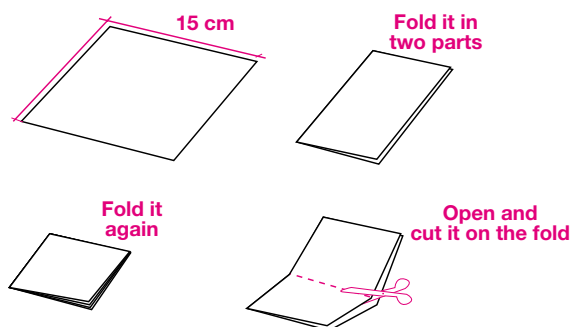

- 2** Apply a generous coat (min. 1.0 mm) of UNOLASTIC on the surface of the internal angle and fix RINFOTEX PLUS previously prepared.

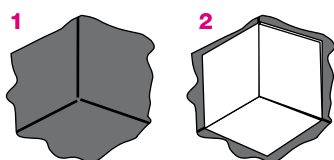

- 3** Spread UNOLASTIC to cover the horizontal surface. Overlap the corner of RINFOTEX PLUS onto UNOLASTIC still wet and press in order to guarantee complete bonding without any folds being formed.

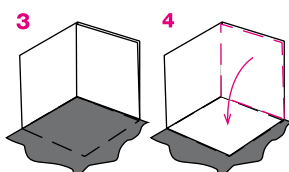

- 4** Apply a generous coat (min. 1.0 mm) of UNOLASTIC on the surface of the external angle and fix RINFOTEX PLUS previously prepared.

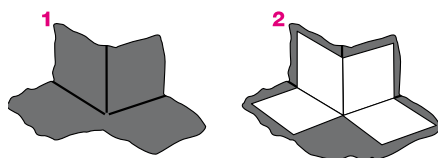

- 5** Spread UNOLASTIC to cover RINFOTEX PLUS on the horizontal part. Fix a piece of RINFOTEX PLUS cut into an "L" shape onto UNOLASTIC still wet, pressing and smoothing it out in order to guarantee complete bonding without any folds being formed.

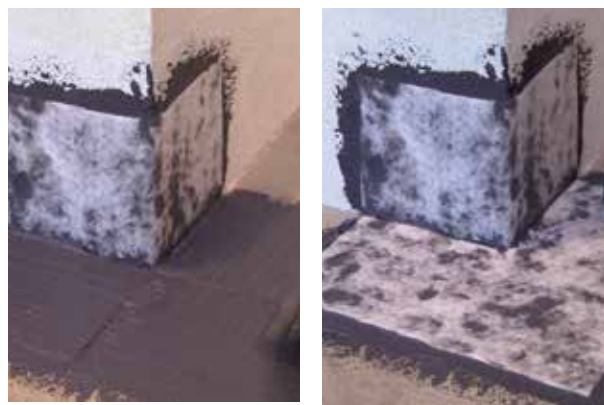
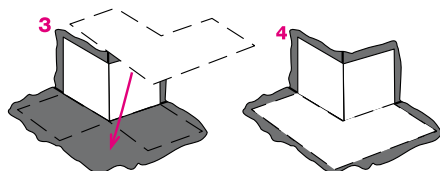

WATERPROOFING THE PERIMETER JOINT (WALL-FLOOR) (with Rinfotex Plus)

- 6** Apply a generous coat (min. 1.0 mm) of UNOLASTIC near the joints, on the floor and the wall, across a width of 10 cm.



- 7** Fix RINFOTEX PLUS onto the wet waterproofing, following the wall-floor joint along the whole perimeter of the surface to be waterproofed. Press to guarantee complete bonding without formation of folds. (Alternatively, the perimeter joint can be waterproofed with COVERBAND ADHESIVE - see page 8)



- 8** After carefully waterproofing all the perimeter joints, generously and uniformly spread UNOLASTIC on the horizontal surface with a thickness of 1.0 mm.



- 9** Overlap RINFOTEX EXTRA or RINFOTEX PLUS on UNOLASTIC while it is still wet and press to guarantee uniform adhesion.



- 10** Carefully cover RINFOTEX EXTRA or RINFOTEX PLUS with UNOLASTIC with a total coverage approx 3-3.5 kg/m².

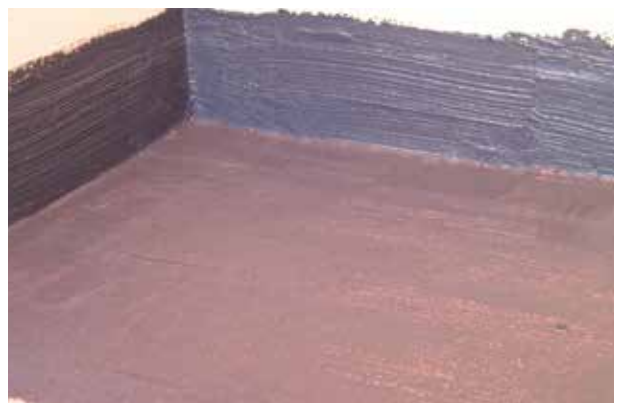

WATERPROOFING (General rules)

- 1** Apply the following primer if necessary:
- PRIMER FIX on crumbling substrates;
 - PRIMERBLOCK or EPOSTOP ABC on damp substrates



- 2** Apply UNOLASTIC with a smooth trowel in thicknesses of about 1.0 mm pressing to obtain maximum adhesion to the foundation. The thickness obtained depends on the surface finish and the flatness of the foundation



- 3** When necessary (surface areas of more than 25 m²) bury the reinforcement RINFOTEX EXTRA or RINFOTEX PLUS, pressing it onto the first layer of UNOLASTIC when it is still wet



- 4** While spreading the second coat of UNOLASTIC, cover all the RINFOTEX EXTRA or RINFOTEX PLUS reinforcement carefully with a total coverage approx 3-3.5 kg/m².



- 5** The laying of UNOLASTIC is finished. Protect UNOLASTIC from frost and rain until complete hardening of the product. (see technical advise - pages 4-5)





QR code

TAG

APPLICATION OF DRAIN

- 1 Cut a piece of RINFOTEX PLUS of about 40x40 cm sufficient to completely cover the external circumference of the drain flange.
Then cut the centre, following the drawing.

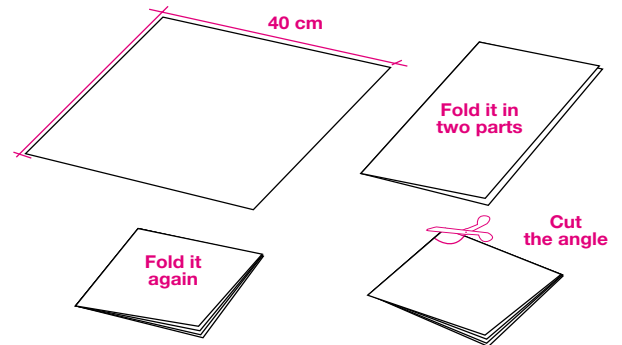

- 2 Apply a generous coat (min. 1.0 mm) of UNOLASTIC on the surface where the drain is to be inserted



- 3 Place the drain on UNOLASTIC while it is still wet.
After pressing well, to guarantee complete bonding, cover the flange with UNOLASTIC with a thickness about 1.0 mm



- 4 Place the square of RINFOTEX PLUS pressing strongly in order to guarantee complete bonding without the formation of folds



- 5 Carefully cover RINFOTEX PLUS and the whole surface with UNOLASTIC with a total coverage approx 3-3.5 kg/m².





QR code



TAG

METHOD OF USE

APPLICATION OF VENT

1

Cut a circle of RINFOTEX PLUS with a sufficient diameter to generously cover the base of the vent. Then cut the centre, following the drawing.

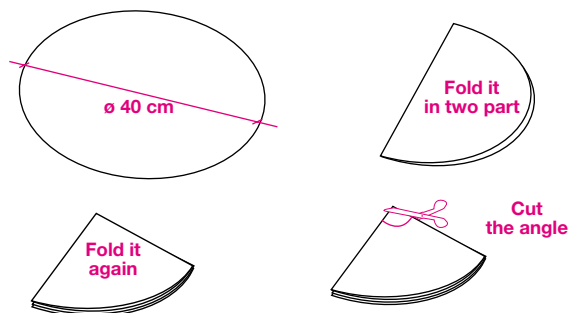

2

Apply a generous coat (min. 1.0 mm) of UNOLASTIC on the surface of the vent and covering another 10 cm of the support



3

Position the circle of RINFOTEX PLUS on UNOLASTIC while it is still wet and press to guarantee complete bonding without the formation of folds



4

Apply UNOLASTIC on the surface to waterproof



5

Carefully cover RINFOTEX PLUS and the whole surface with UNOLASTIC with a total coverage approx 3-3.5 kg/m². The finished work is then connected with the rest of the waterproofing



**WATERPROOFING A ROOF
GUTTER DETAIL**

Display on your smartphone the application instruction video of these pages



QR code



TAG

- 1** Apply a generous coat (min. 1.0 mm) of UNOLASTIC on the corner surface between the roof and the gutter across a width of 10 cm



- 2** Place a strip of RINFOTEX PLUS 15 cm wide on UNOLASTIC while it is still wet and press to guarantee complete bonding without formation of folds



- 3** Carefully cover RINFOTEX PLUS with a coat of UNOLASTIC with a total coverage approx 3-3.5 kg/m²



- 4** Proceed to apply a generous coat (min. 1.0 mm) of UNOLASTIC on the surface of the roof

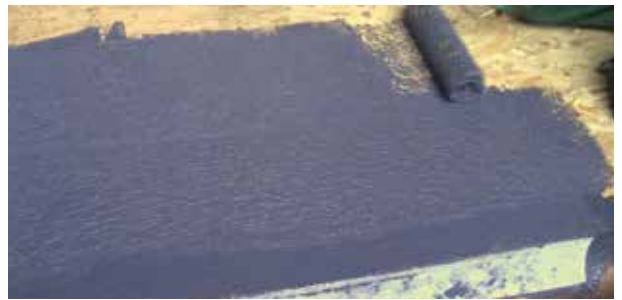

- 5** Spread RINFOTEX EXTRA or RINFOTEX PLUS on UNOLASTIC while it is still wet
- Press strongly with a roller so as to fix the reinforcement uniformly on UNOLASTIC



- 6** Spread UNOLASTIC so as to carefully cover RINFOTEX EXTRA or RINFOTEX PLUS with a total coverage approx 3-3.5 kg/m².

Finish off the waterproofing details with a brush



PATCHING UP SLATED COVERINGS

- 1** Clean the surface, spread an abundant coat of UNOLASTIC (minimum 1.0 mm) over the roof surface.



- 2** Spread RINFOTEX EXTRA or RINFOTEX PLUS over UNOLASTIC whilst still wet.



- 3** Spread UNOLASTIC so that it thoroughly covers the reinforcement with a total coverage approx 3-3.5 kg/m².



- 4** Cover the whole surface back up again.



REFERENCES



TECHNICAL CHARACTERISTICS

	Standard	UNOLASTIC
Appearance		Paste
Colour		Brown - Grey - Black
Density of mix	EN 2811-1	1.50 ± 0.05 kg/ℓ
Flammability		non-flammable
Shelf life in original packaging (dry stored)		12 months
Workability	Standard	
Application temperature		+5°C ÷ +35°C
Maximum application thickness		3 mm (two coats)
Waiting time - touch dry (*)		6 hours
Waiting time - complete drying (*)		4 days
Waiting time - recoating (*)		24 hours
Waiting time - for application of ceramic or paints (*)		4 days
Adhesives class for application of ceramic		C2S1, in compliance with EN 12004:2007+A1:2012
Application		manual or spray
Performance characteristics	Standard	Product performance
Class and Type	EN 1504-2	C PI-MC-IR
Class and Type	EN 14891	DM OP
Watertightness	EN 14891	>500 KPa - waterproof
Cold flexibility	UNI 1109	-10°C
Water vapour permeability	EN 7783	5 m ≤ Sd <50 m - class II
Adhesion strength	EN 1542	≥2.0 MPa
Initial adhesion strength - after 28 days	EN 14891	≥1.0 N/mm ²
Adhesion strength - after water dipping	EN 14891	≥1.0 N/mm ²
Adhesion strength - after basic water dipping	EN 14891	≥0.5 N/mm ²
Adhesion strength - after chlorate water dipping	EN 14891	≥0.5 N/mm ²
Adhesion strength - after heat	EN 14891	≥1.5 N/mm ²
Adhesion strength - after thaw-frost cycles	EN 14891	≥1.0 N/mm ²
Adhesion strength - to glass		≥1.0 N/mm ²
Adhesion strength - to steel		≥1.0 N/mm ²
Adhesion strength - to wood		≥1.0 N/mm ²
Tear resistance	NFT 46002	240±40%
Tear resistance - with reinforced RINFOTEX PLUS	EN 12311-1	80±10%
Crack bridging ability at +20°C	EN 14891	>3.5 mm
Crack bridging ability at -5°C	EN 14891	≥1.5 mm
Crack bridging	EN 1062-7	>2.5 mm - class A5
Crack bridging - with reinforcement RINFOTEX PLUS	Internal method	>10.0 mm
Ultimate tensile strength	NFT 46002	1.4±0.3 MPa
Ultimate tensile strength - with reinforcement RINFOTEX PLUS	EN 12311-1	520±50 N
Resistance to static loading - method A	EN 12730	45 kg
Resistance to static loading - method B	EN 12730	25 kg
Resistance to impact - method A	EN 12691	1 000 mm
Resistance to impact - method B	EN 12691	1 000 mm
Capillary water absorption	EN 1062-3	w < 0.01 kg/m ² ·h ^{0.5}
Permeability to CO₂	EN 1062-6	Sd >50 m
Thermal resistance - Operating temperature		-30°C ÷ +80°C
Hazardous substances	EN 1504-2	in accordance to ZA.1 note

Test conditions: temperature 23±2°C, 50±5% R.H. and air velocity in test area <0.2 m/s. May vary depending on specific site conditions: temperature, ventilation, moisture and absorbency of the substrate.

(*) The times indicated will be longer or shorter as the temperature drops or rises.

Pursuant to European standard EN 1504-9 and EN 14891 - General principles for the use of products and systems.

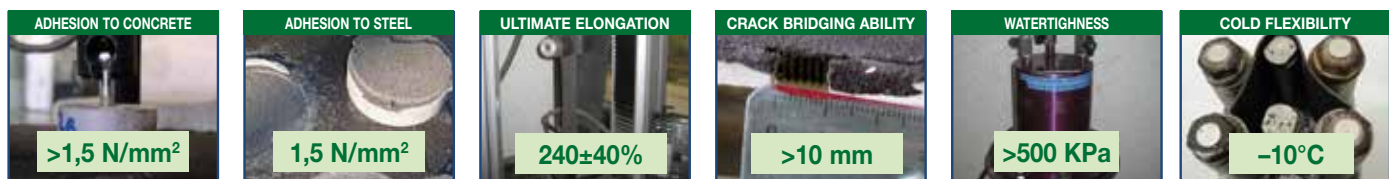

the numerous possible uses and the possible interference of conditions or elements beyond our control, we assume no responsibility regarding the results which are obtained. The purchasers, of their own accord and under their own responsibility, must establish the suitability of the product for the envisaged use.

The figures shown are average indicative figures relevant to current production and may be changed or updated by INDEX at any time without previous warning. The advice and technical information provided, is what results from our best knowledge regarding the properties and the use of the product. Considering

<p>Construction Systems and Products</p> <p>Via G. Rossini, 22 - 37060 Castel D'Azzano (VR) - Italy - C.P.67 Tel. +39 045.8546201 - Fax +39 045.518390</p>	<p>Internet: www.indexspa.it Informazioni Tecniche Commerciali tecom@indexspa.it Amministrazione e Segreteria index@indexspa.it Index Export Dept. index.export@indexspa.it</p>		<p>UNI EN ISO 9001</p>	<p>UNI EN ISO 14001</p>	<p>INDEX Italia Associated</p>	